

Transformer switching relay | Type TSRD



Note: Installation and commissioning have to be undertaken by a qualified person or a person under the supervision of a specialist.

intelligent electronics

FSM®

With TSRD the both three-phase transformers and combinations of three individual single-phase transformers can be switched-on in a three-phase network without inrush currents arising. The required application is selected using DIP-switches.

Note in safety

Potential separation does not occur during switching of the TSRD as additional RC elements are connected between the input and the output thyristor clips. To bypass the thyristors, a bypass contactor must be connected in parallel to the TSRD.

General

The required application is selected using DIP-switches. In the case of applications N and L the transformer core type must be selected at TP1 (transformer type) The TSRD has a Message Display Output (Message 1). Depending on the DIP-switch selections four different conditions can be displayed. The DIP-switches should be set only when the power is off.

Applications

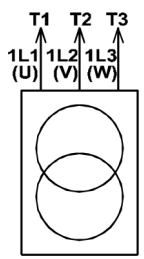
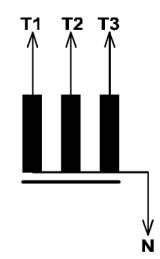
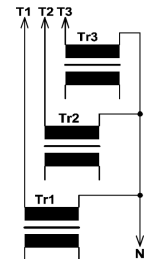
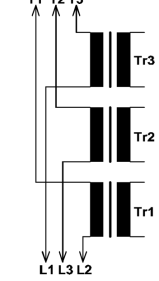
Application D	Application S	Application N	Application L
Three-phase transformer, primary side delta or star config. without N (neutral) (arbitrarily loading). Winding direction important for transformer connection.	Three-phase transformer, primary side star config. with N (neutral) (arbitrarily loading). Winding direction important for transformer connection.	3 single-phase transformers having the same core (arbitrarily loading). The core type is set at TP1.	3 single-phase transformers having the same core (arbitrarily loading). The core type is set at TP1.
			

DIP-Switches

No.	Function	Position		
1	Error handling	OFF	No automatic restart	
		ON	Automatic restart after an error	
2	Rotation direction recognition	OFF	Switched-on for clockwise phase-sequence	
		ON	Switched-on for clockwise and anticlockwise phase-sequence	
3	Control input 1 (Remote-on input)	OFF	Control input enabled for external control signal	
		ON	Switched-on without external control signal	
4	Control input 2	OFF	Control input enabled for additional external control signal	
		ON	Switched-on without external control signal	
5/6	Message display 1	5	6	Function Message Display 1:
		OFF	OFF	Fully-on message
		ON	OFF	OK message
		OFF	ON	Error message
		ON	ON	Bypass contactor control

	7	8	Application type:
7/8 Applications	OFF	OFF	D, Three-phase transformer, delta or star config. without MP
	ON	OFF	S, Three-phase transformer, star configuration with MP
	OFF	ON	N, 3 Single phase transformer between phase and N
	ON	ON	L, 3 Single phase transformer between two phases

Setting premagnetisation on the trimming potentiometer depending on transformer type

On the trimmer potentiometer TP1 the transformer core type of the single-phase transformer being used for application N or L must be set. For applications D and S the trimmer function does not apply.

Toroidal core transformers set to position R

Coil form (shell) transformers (stack-core transformers): Set to position P (factory setting)

The correct position for stack-core transformers (P) can vary between the „10- and 2 o'clock „ position.

Strip-wound cut core transformers: Potentiometer setting between the „P“ and „R“ settings

Messages

The LED „Message Display 1“ (yellow) is illuminated, when the relay contact between the terminals 23 and 24 is closed. The Message Display1 can be applied for various functions.

Fully-On message: The relay contact is closed, as soon as the connected transformer has been fully switched-on by the TSRD when the premagnetisation (remnance setting) is completed.

OK message: The relay contact is closed after power is supplied to the TSRD and initialisation is complete . On malfunction the contact is opened.

Error message: On malfunction the contact is closed.

Bypass contactor: The relay contact is used to control a bypass contactor, used to bridge the control elements.

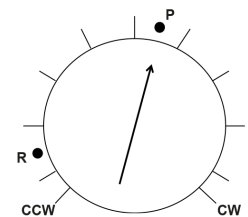

OK-LED

The LED OK (green) is illuminated when the TSRD is in the 'OK' status. Malfunctions are indicated by different flashing rates.

Flashing rate	Interference
continuous	OK state
10 Hz	A remote-on signal has been applied, and no automatic resetting after malfunction (DIP1=Off)
5 Hz	Three-phase network is counter-clockwise, and switching-on only for clockwise phasesequene (DIP2=Off)
1 Hz	The supply voltage is outside the limiting voltage values (-20/+15% of U _{rated})
10 Hz	Internal error

Additional information

Bypass-contactor: To protect the safety coil it is recommended to connect an RC-element parallel to the coil.

Fuse: The need in the data sheet under „Current“ defined limits are met. If this is not possible, the TSRD should according to the circuit example (see last page) are connected.

Terminal connection diagram

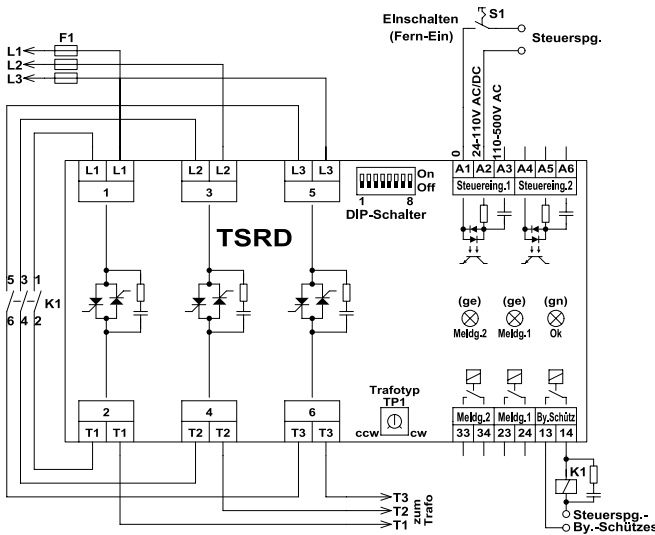

Fuse with F1:

The need in the data sheet (Page 3) under „Current“ defined limits are met. If this is not possible, the TSRD should according to the circuit example (see last page) are connected.

Application Description

Application-Description of the coil inter-connection at 3 phase transformers for a particular vector group. For the correct function of the Transformer Switching Relay TSRD, to switch on 3 phase transformers without inrush current peaks, the transformer coil endings must be connected in the right manner to the TSRD and must also be inter-connected in the right manner for the particular vector group.

What means the begin of the coil, marked with a dot, and the definition of the direction of the bring up for the windings

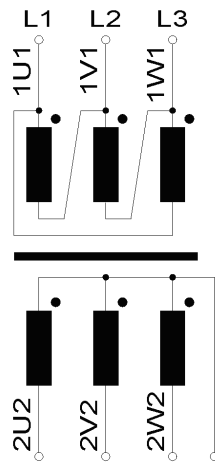
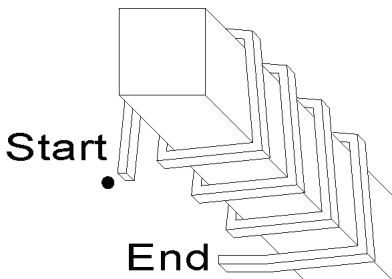

Usual manner of the inter connection from the coils for a Delta Star vector group and the connections from the transformer clamps L1, L2, L3 to the clamps L1, L2, L3, from the TSRD, when windings are put on in a clockwise manner onto the Iron core, if looking to the top of the coil and to the winding start, for a DYN5 vector group transformer.

The dot marks the begin, start, of the windings on the view from top for the bringing up of the windings.

Sometime it happens, that the coils are produced in a count clock wise winding direction onto the core, like showed in the bottom left. The numbering of the clamps of the transformer must than be changed like showed in the picture in the bottom right, L3 left and L1 right and similar connected L3 to L3 and L1 to L1 of the TSRD, for softstart the transformer without inrush current peaks, via the TSRD and only with the value of the no load current at a delta vector group of the primary side. (The interconnection of the coils for the Delta vector group is then corresponding to the connections showed in the picture on the top right, L1 left and L3 right.)

View to top of the iron core, if the coils are produced in a count clock wise manner.

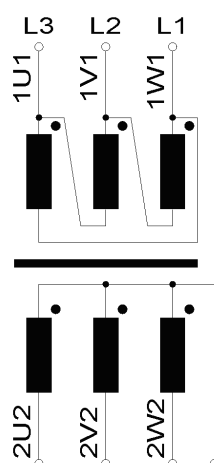
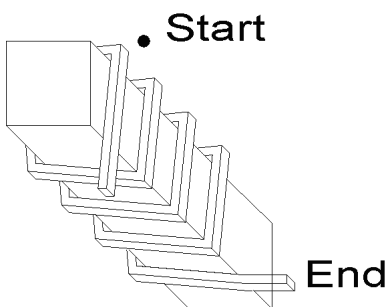

View to top of the iron core, if the coils are produced in a count clockwise manner.

Thats not usual but it can happen. Connections for the Delta vector group in the usual manner, however with exchanged connections L1 and L3, if the windings are bring up count clock wise..

Disclaimer:

Improper installation and commissioning can result in property damage and endanger people in a row. FSM AG accepts no responsibility or liability for loss, damage or expense resulting from improper installation, commissioning improper operation, and improper use and maintenance.

Circuit Example

TSRD is separately fused with fast blowing types to protect the thyristors inside the TSRD, if the connection cables to and from the TSRD are small and long enough. This is recommended if the output of the transformer can have a short circuit, while start procedure. The fuses directly in front of the TSRD are selective to the fuses on the input of the schematic drawing. The transformer have to be softstarted in a no-load or low-load state. During the softstart only the no load current value is flowing (at the delta vector group). Then can be softstarted a transformer with a higher value of current like TSRD has. The TSRD only start the transformer then he activates the bypass contactor. This contactor is going in a self holding mode and switches the TSRD off with his opener contacts. If any overload or Power line failures occurs, the TSRD is not influenced with overcurrents or wrong softstart repeating attempts, because he is switched off as long as the Bypasscontactor is closed.

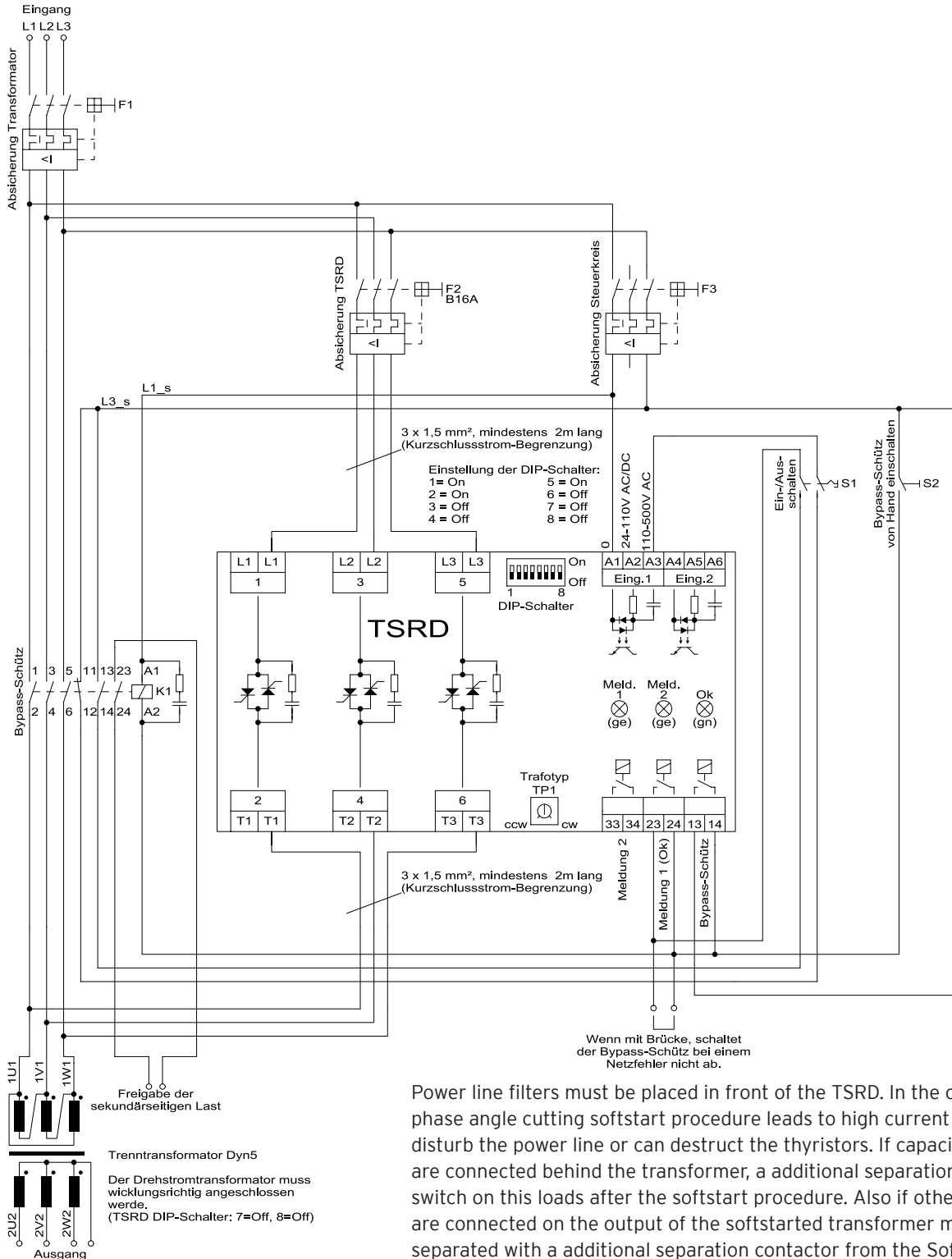

Power line filters must be placed in front of the TSRD. In the other way the phase angle cutting softstart procedure leads to high current peaks and can disturb the power line or can destruct the thyristors. If capacitive AC- loads are connected behind the transformer, a additional separation contactor must switch on this loads after the softstart procedure. Also if other transformers are connected on the output of the softstarted transformer must these be separated with a additional separation contactor from the Softstart transformers output, while he is in Softstart procedure. If high valued capacitors are placed after rectifiers behind the softstarted transformer, a special softstart procedure can also soft start these capacitors. Look to the special order numbers.